

Radio samochodowe Kenwood KRC-777R/RV, KRC-877R/RV/W/WY, KRC-977R/RV, KRC-PS1077R/RV

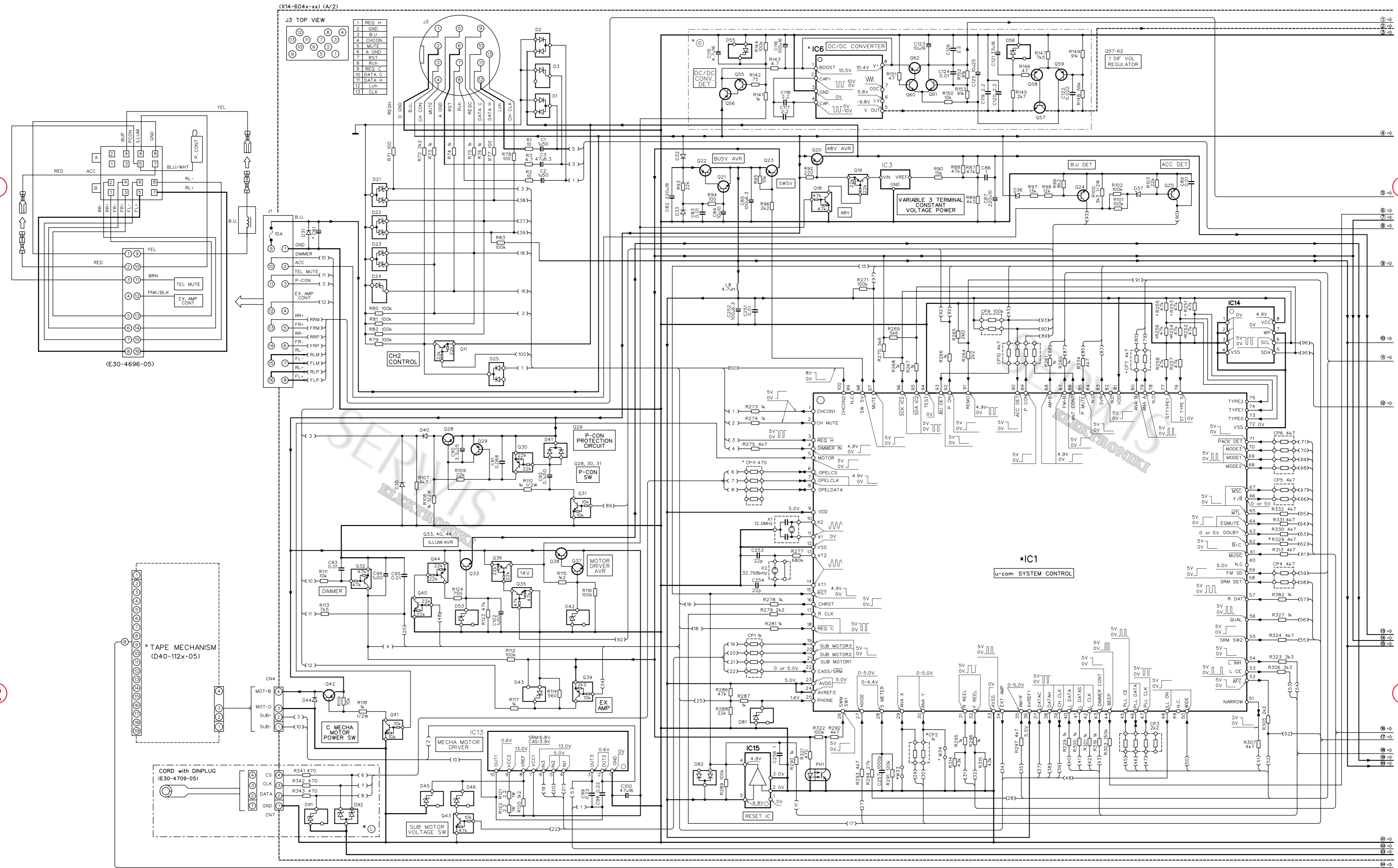

Radio samochodowe Kenwood

KRC-777R/Ry, KRC-877R/Ry/W/Wy, KRC-977R/Ry, KRC-PS1077R/Ry

1

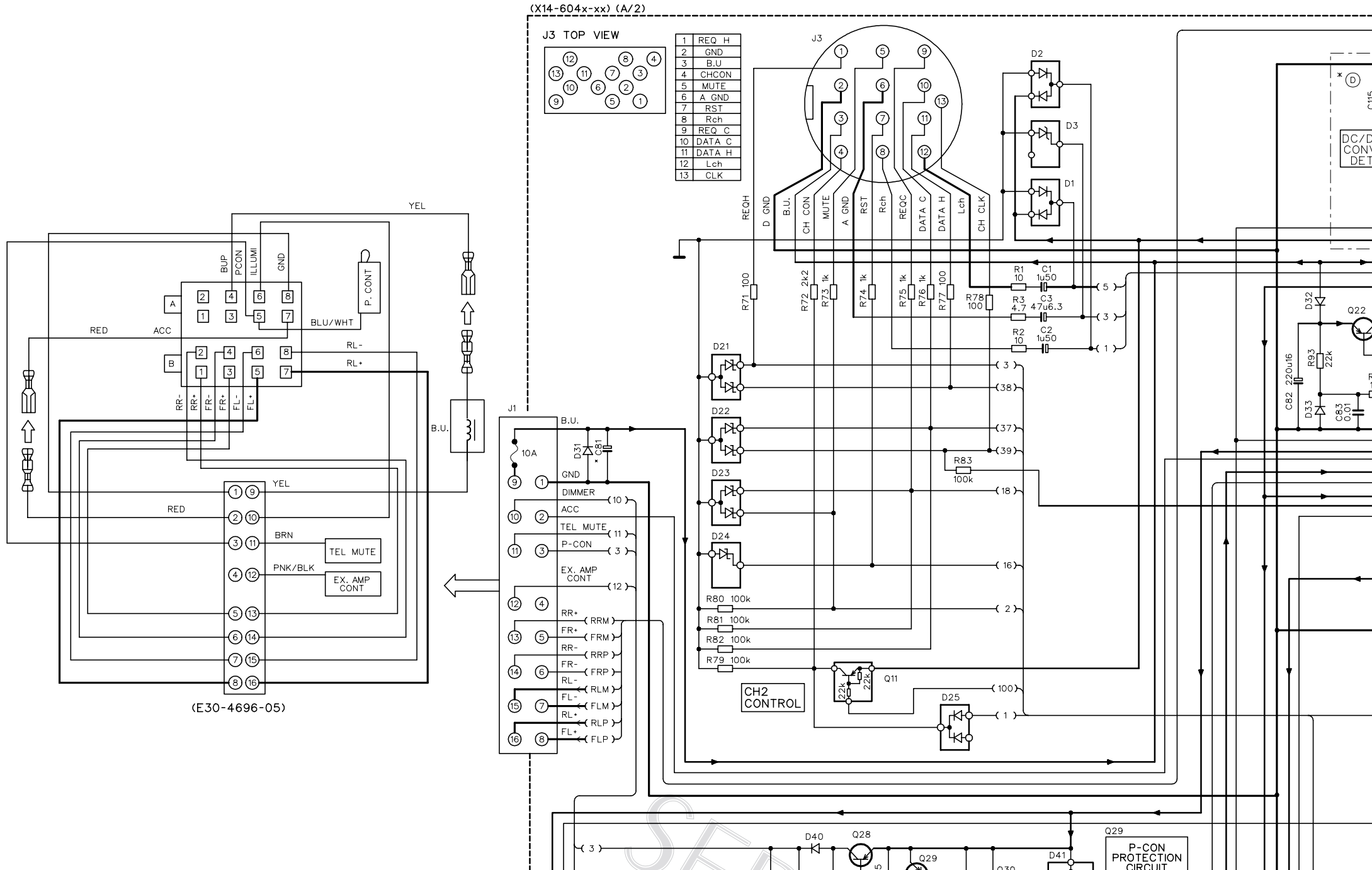

(E30-4696-05)

(X14-604x-xx) (A/2)

J3 TOP VIEW

1	REQ H
2	GND
3	B.U.
4	CHCON
5	MUTE
6	A_GND
7	RST
8	Rch
9	REQ C
10	DATA C
11	DATA H
12	Lch
13	CLK

J3

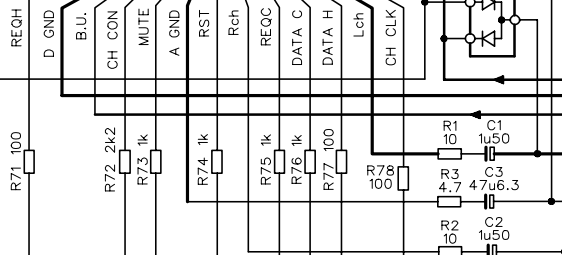

P-CON PROTECTION CIRCUIT

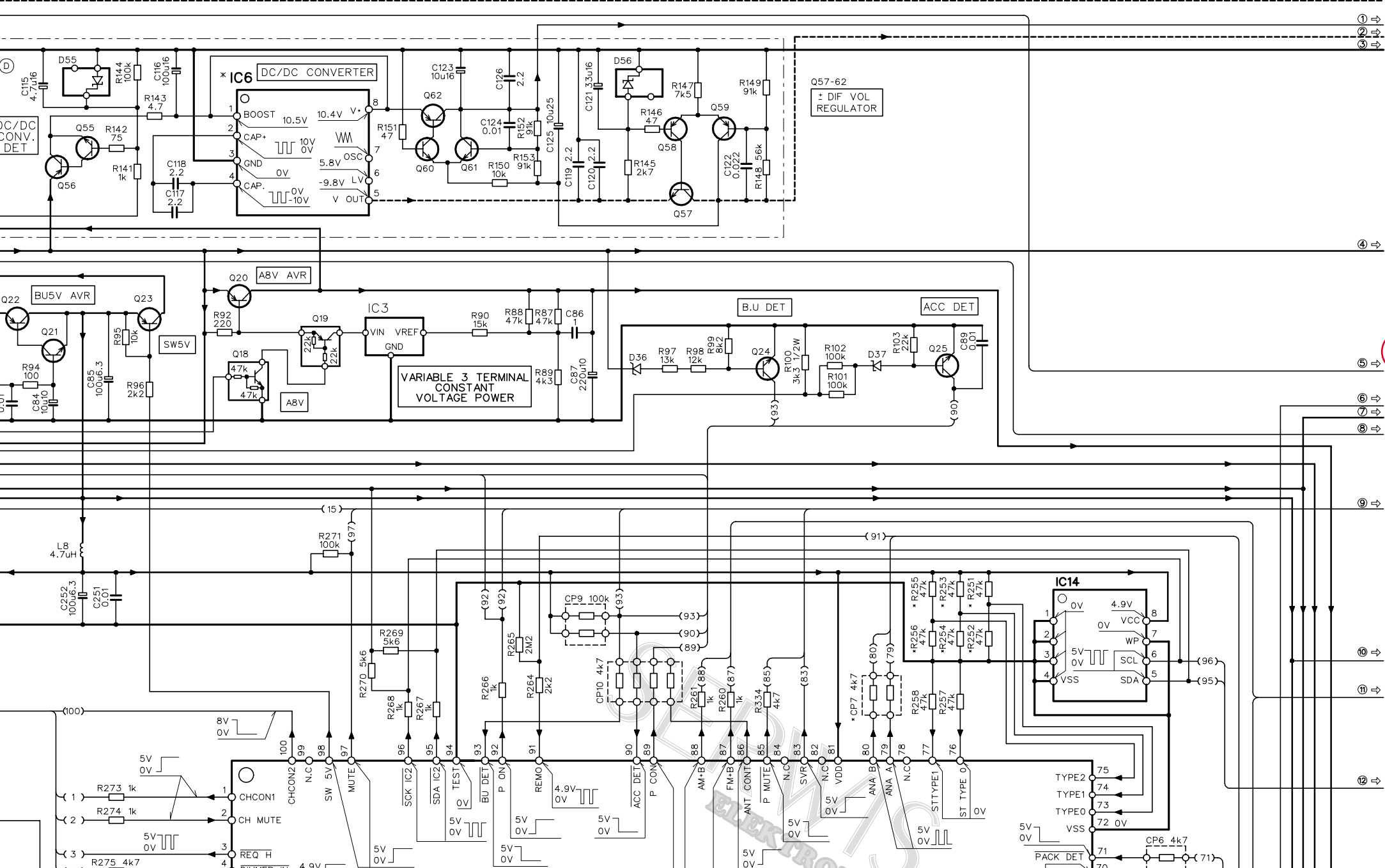

1

2

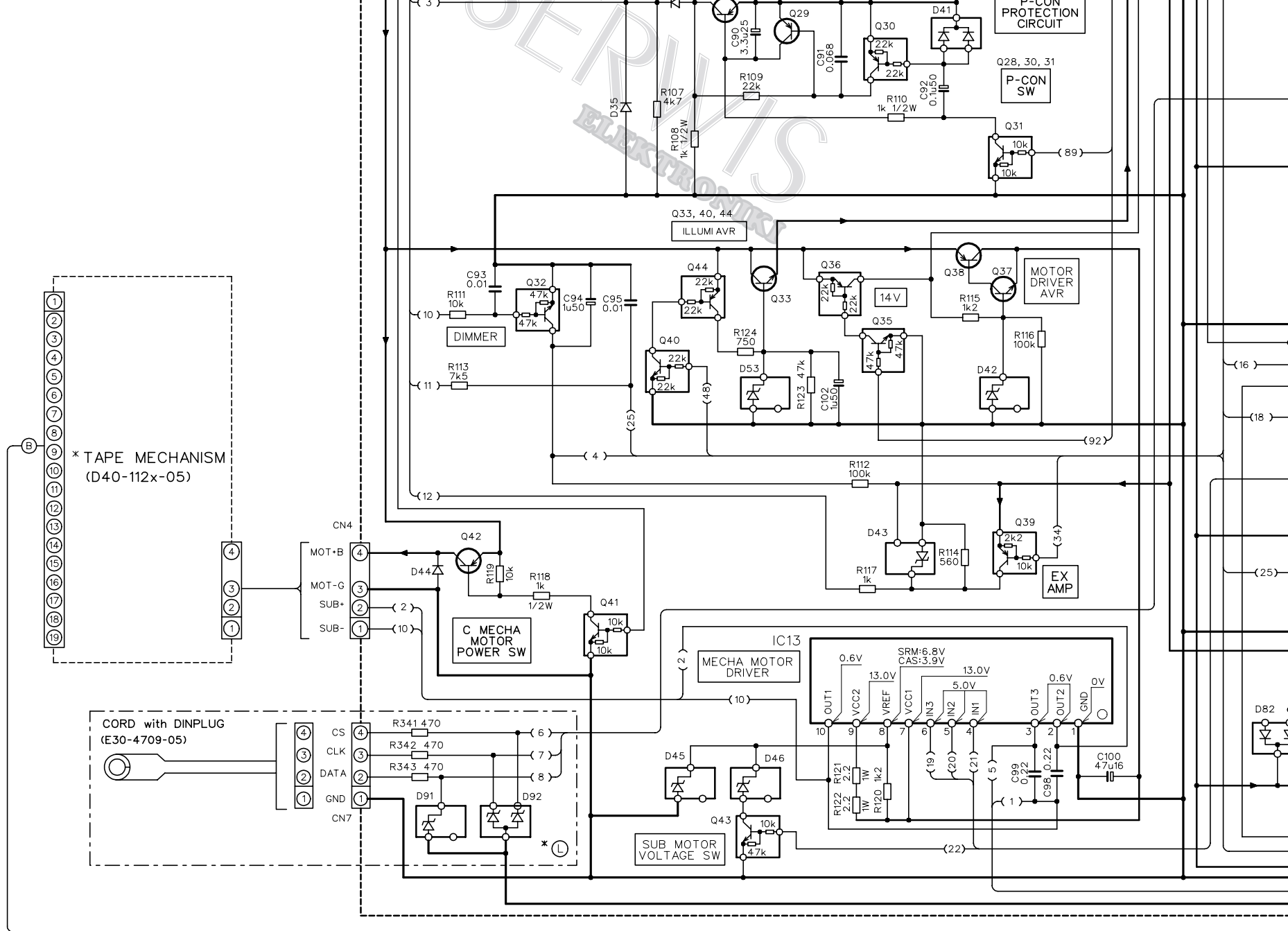

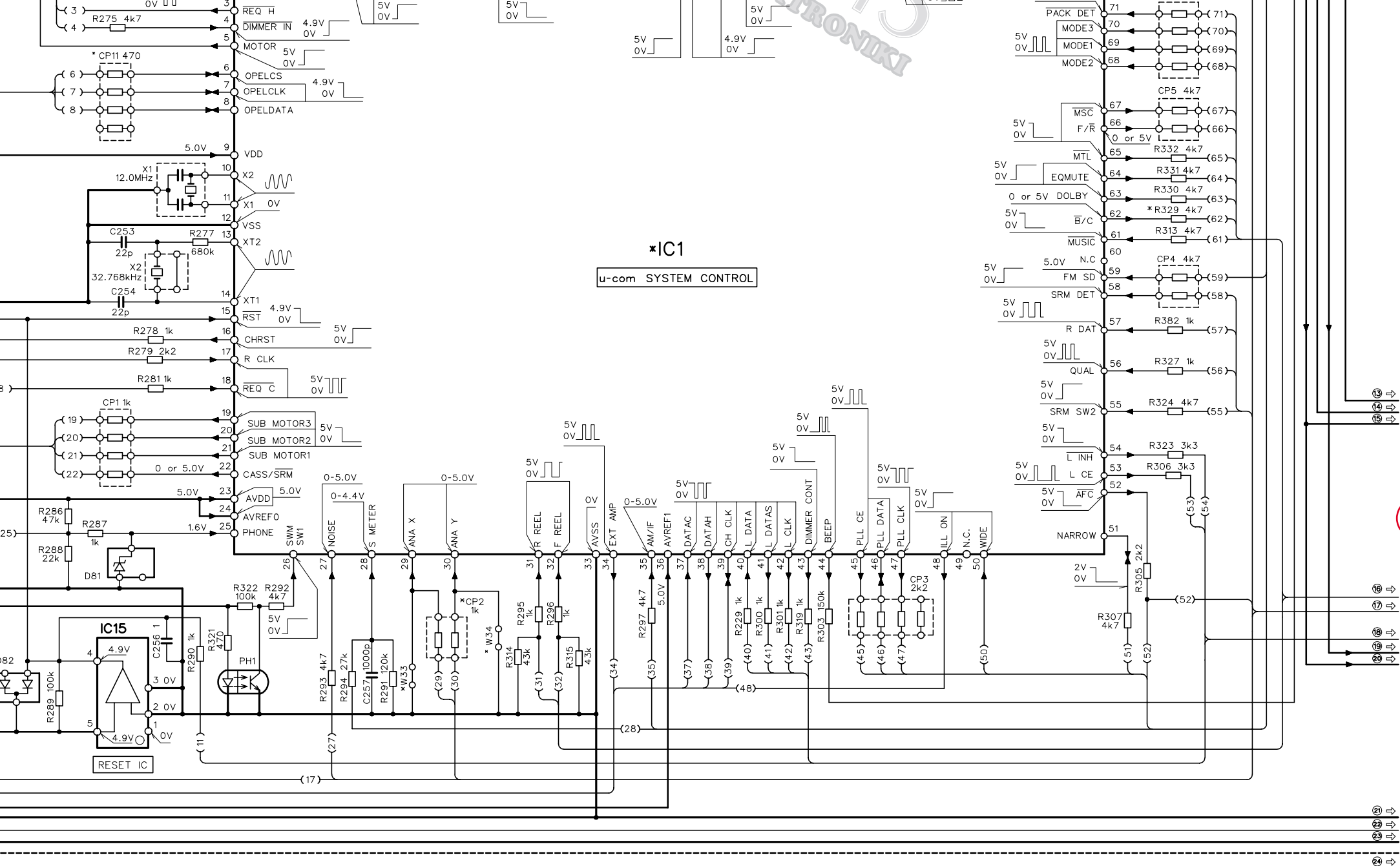

*IC1
u-com SYSTEM CONTROL

2

Radio samochodowe Kenwood KRC-777R/Ry, KRC-877R/Ry/WWy, KRC-977R/Ry, KRC-PS1077R/Ry

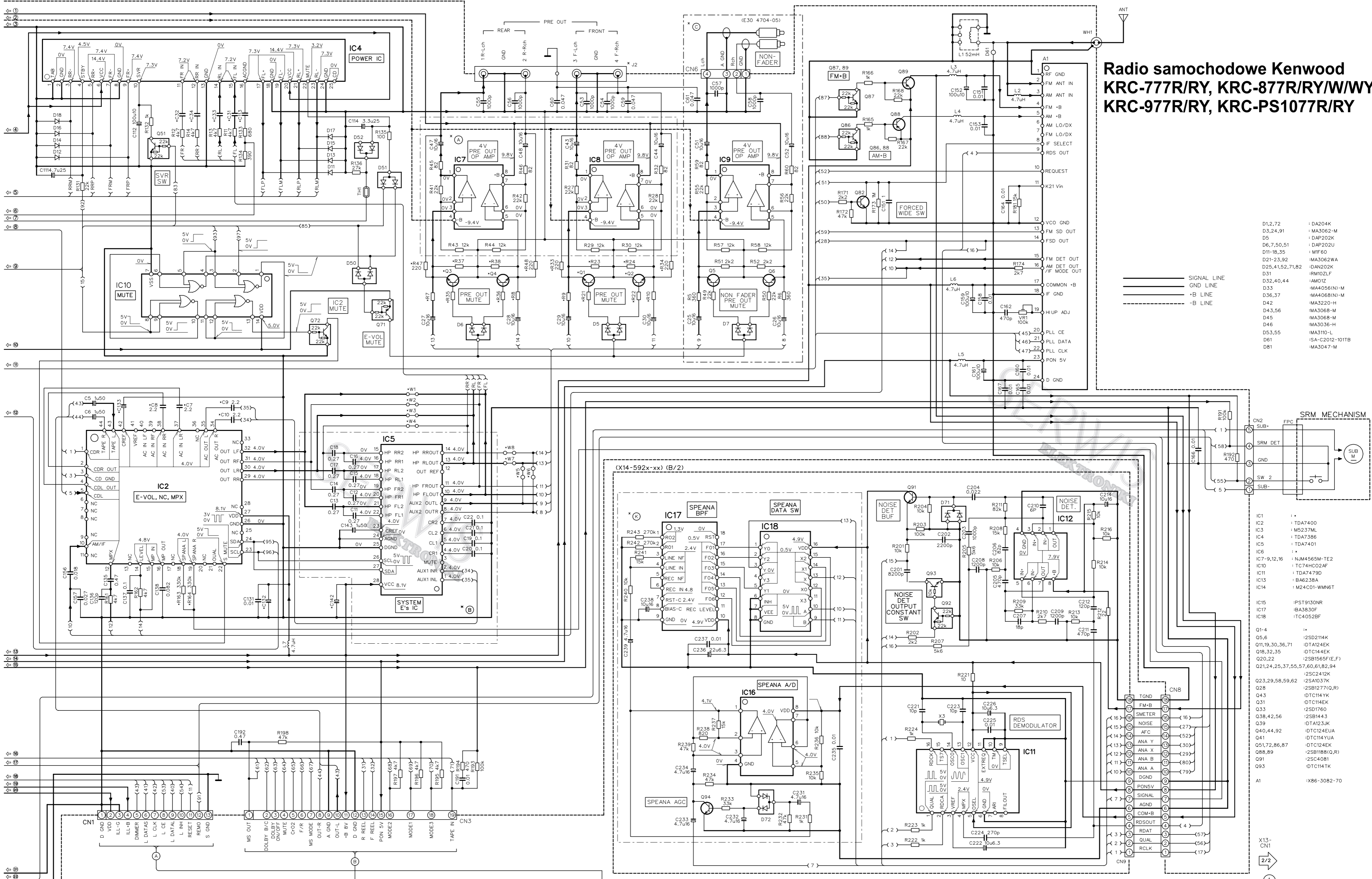

- Legend:
- SIGNAL LINE
 - GND LINE
 - B LINE
 - B LINE
- Component List:
- D1,2,72 : DA204K
 - D3,24,91 : MA3062-M
 - D5 : DAP202K
 - D6,7,50,51 : DAP202U
 - D11-18,35 : MF60
 - D21-23,92 : MA3062WA
 - D25,41,52,71,82 : DAN202K
 - D31 : RM10ZLF
 - D32,40,44 : AMOIZ
 - D33 : MA4056(IN)-M
 - D36,37 : MA4068(IN)-M
 - D42 : MA3220-H
 - D43,56 : MA3068-M
 - D45 : MA3068-M
 - D46 : MA3036-L
 - D53,55 : MA310-L
 - D61 : SA-C2012-101TB
 - D81 : MA3047-M

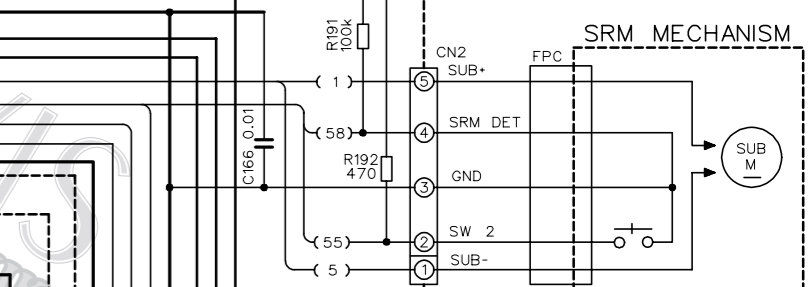

- Component List:
- IC1 : TA7400
 - IC2 : M5237ML
 - IC3 : TA7401
 - IC4 : TA7401
 - IC5 : TA7401
 - IC6 : TA7401
 - IC7-9,12,16 : NU4565M-TE2
 - IC10 : TC74HC02AF
 - IC11 : TA74790
 - IC13 : BA6238A
 - IC14 : M24C01-WM6NT
 - IC15 : PS19130NR
 - IC17 : BA3830F
 - IC18 : TC4052BF

- Component List:
- Q1-4 : 2SD214K
 - Q5,6 : DT124EK
 - Q11,19,30,36,71 : DT144EK
 - Q18,32,35 : DT144EK
 - Q20,22 : 2SB1565F(E,F)
 - Q21,24,25,37,55,57,60,61,82,94 : 2SC2412K
 - Q23,29,58,59,62 : 2SA1037K
 - Q28 : 2SB1277(G,R)
 - Q43 : DT144YK
 - Q31 : DT144EK
 - Q33 : 2SD1760
 - Q38,42,56 : 2SB1443
 - Q39 : DT123JK
 - Q40,44,92 : DT124EU
 - Q41 : DT124YU
 - Q51,72,86,87 : DT124EK
 - Q88,89 : 2SB1188(G,R)
 - Q91 : 2SC4081
 - Q93 : DT144TK

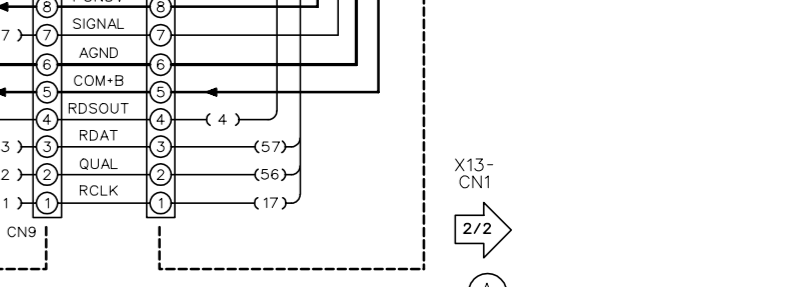

(X14-604x-xx)

MODEL NAME	UNIT No	A	D	K	B	C	L	C7	C10	C11	C12	C13	C14	R7	R10	R21,22	R23,24	R25,26	R33,34	R35,36	R63	R64	R251	R252
KRC-PS1077R/Ry	2-70	YES	YES	YES	YES	NO	YES	0.22	C90-2822	1	47u10	2.2u50	22u25	360	22k	2k2	NO	NO	NO	NO	NO	NO	NO	YES
KRC-977R/Ry	2-71	YES	YES	NO	NO	YES	YES	0.22	C90-2822	1	1u50	1u50	47u10	360	22k	2k2	NO	NO	NO	NO	NO	NO	NO	NO
KRC-877R/Ry	2-72	NO	YES	NO	YES	YES	YES	0.22	C90-5243	1	1u50	1u50	47u10	270	4k7	22k	YES	NO	NO	NO	NO	NO	NO	NO
KRC-777R/Ry	2-73	NO	NO	NO	NO	NO	NO	0.12	C90-5243	0.47	1u50	1u50	NO	270	4k7	22k	YES	NO	NO	NO	NO	NO	NO	NO
KRC-877W/Wy	2-74	NO	NO	YES	NO	NO	NO	0.22	C90-5243	1	1u50	1u50	47u10	270	4k7	22k	YES	NO	NO	NO	NO	NO	NO	NO

(X14-604x-xx)

MODEL NAME	UNIT No	R253	R254	Q1-4	IC1	IC6	J2	CP2	CP11	W1-4	W5	W6	W7	W8	W33	W34	TAPE MECHANISM
KRC-PS1077R/Ry	2-70	NO	YES	NO	2SD214K	UPD784215GCC075	TC7662BE0A	E63-0854(GOLD)	YES	NO	NO	NO	NO	NO	NO	NO	D40-1123-05
KRC-977R/Ry	2-71	NO	YES	NO	2SD214K	UPD784215GCC075	ICL7660SIBA	E63-0853(SILVER)	YES	NO	NO	NO	NO	NO	NO	NO	D40-1123-05
KRC-877R/Ry	2-72	NO	YES	NO	2SC2412K	UPD784215GCC096	NO	E63-0853(SILVER)	NO	YES	NO	NO	NO	NO	NO	NO	D40-1123-05
KRC-777R/Ry	2-73	NO	YES	NO	2SC2412K	UPD784215GCC096	NO	E63-0853(SILVER)	NO	NO	YES	NO	NO	NO	NO	NO	D40-1123-05
KRC-877W/Wy	2-74	NO	YES	NO	2SC2412K	UPD784215GCC096	NO	E63-0853(SILVER)	NO	NO	NO	YES	NO	NO	NO	NO	D40-1123-05

KRC-PS1077R/KRC-PS1077RY/KRC-977R/KRC-977RY (1/2)
 KRC-877R/KRC-877RY/KRC-777R/KRC-777RY (1/2)
 KRC-877W/KRC-877WY (1/2)

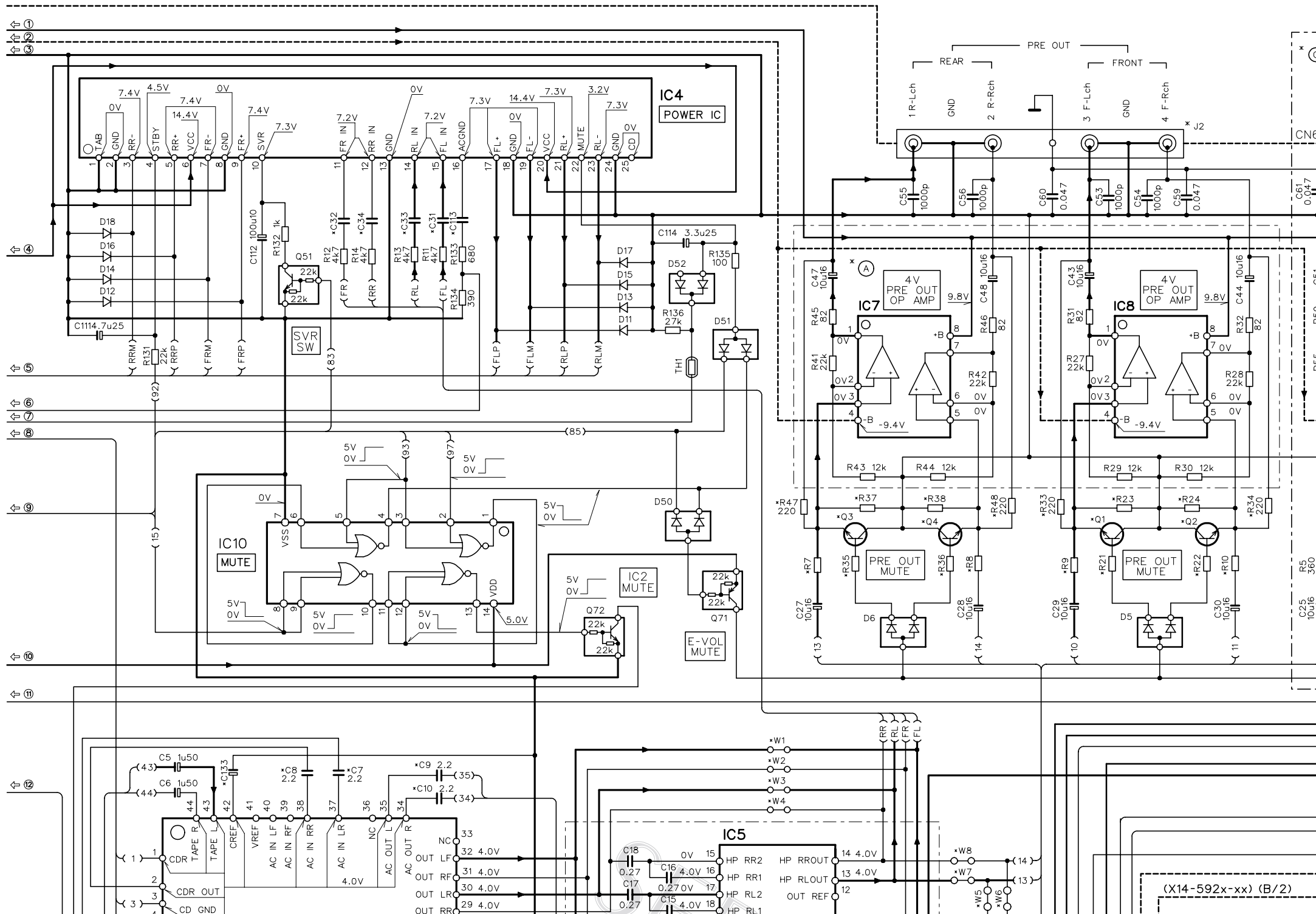

1

(X14-592x-xx) (B/2)

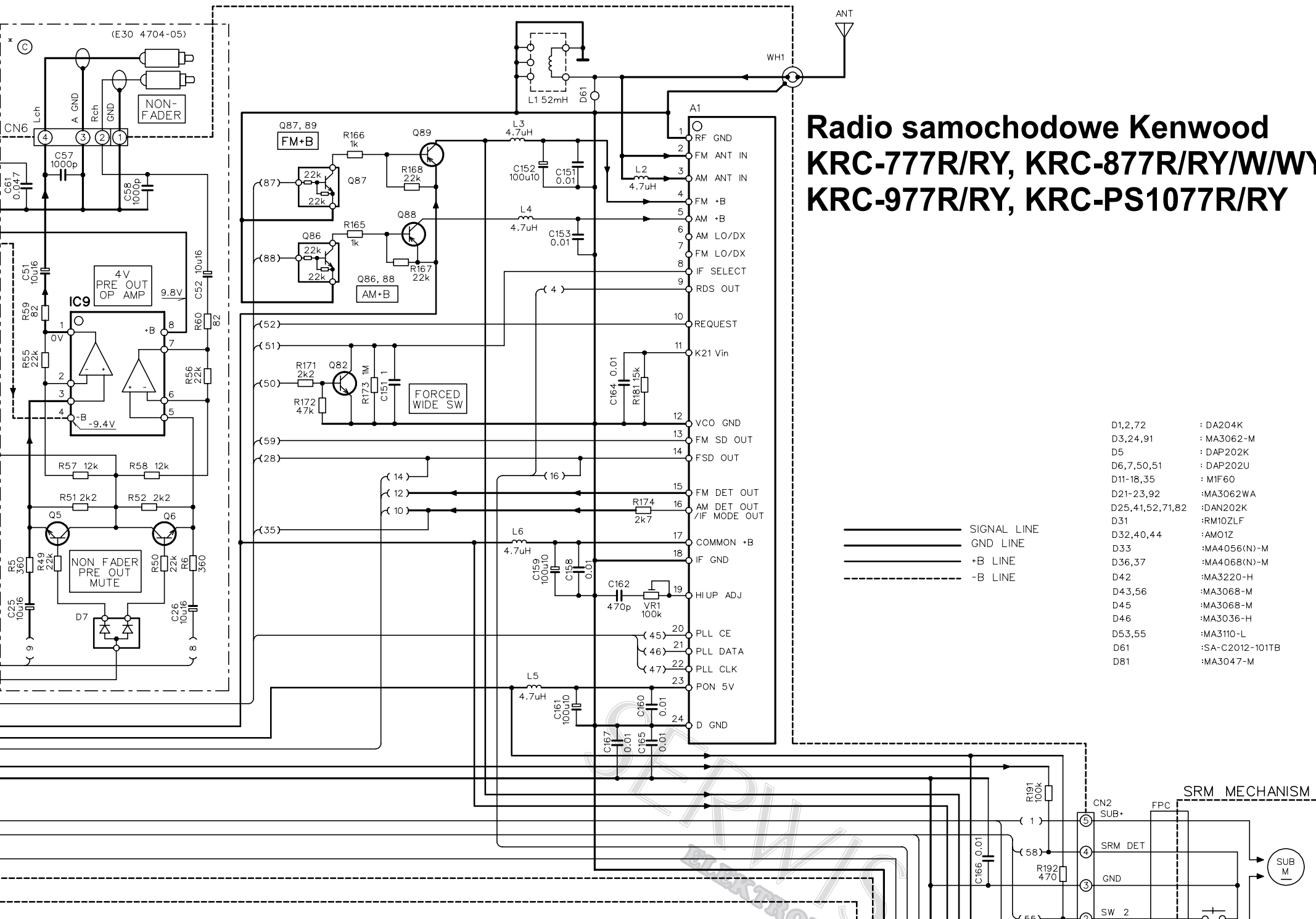

Radio samochodowe Kenwood KRC-777R/Ry, KRC-877R/Ry/W/Wy, KRC-977R/Ry, KRC-PS1077R/Ry

- D1,2,72 : DA204K
- D3,24,91 : MA3062-M
- D5 : DAP202K
- D6,7,50,51 : DAP202U
- D11-18,35 : MIF60
- D21-23,92 : MA3062WA
- D25,41,52,71,82 : DAN202K
- D31 : RM10ZLF
- D32,40,44 : AMO1Z
- D33 : MA4056(N)-M
- D36,37 : MA4068(N)-M
- D42 : MA3220-H
- D43,56 : MA3068-M
- D45 : MA3068-M
- D46 : MA3036-H
- D53,55 : MA3110-L
- D61 : SA-C2012-101TB
- D81 : MA3047-M

——— SIGNAL LINE
 ——— GND LINE
 ——— +B LINE
 - - - -B LINE

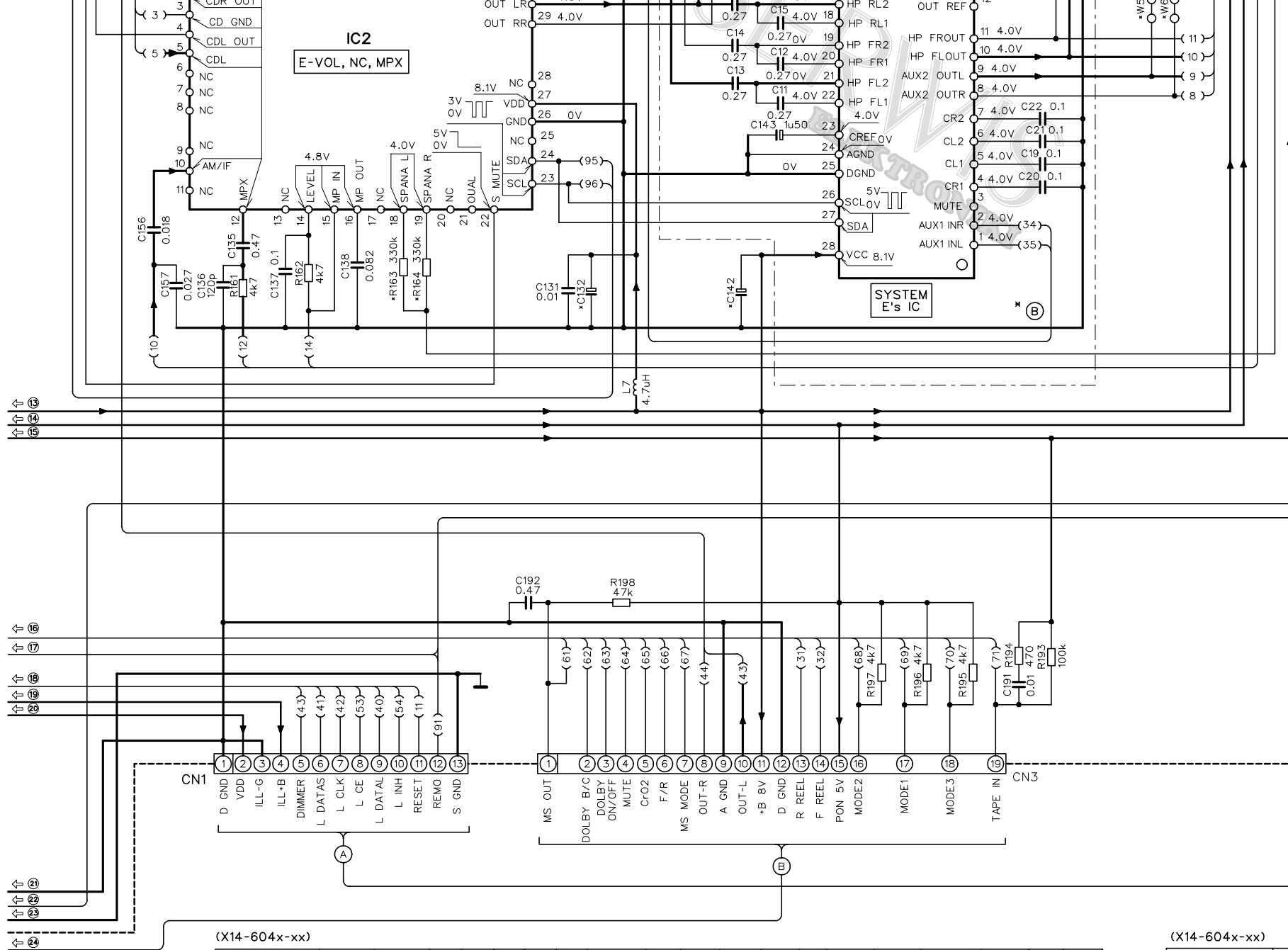

(X14-604x-xx)

MODEL NAME	UNIT No	(A)	(D)	(R)	(B)	(C)	(L)	C7-10	C31-34	C81	C113	C132	C133	C142	R7-10	R21,22,35,36	R23,24,37,38	R33,34,47,48,255	R163,164,256	R251	R252
KRC-PS1077R/Ry	2-70	YES	YES	YES	NO	YES	NO	YES	0.22	C90-2822	1	47u10	2.2u50	22u25	360	22k	2k2	NO	YES	NO	YES
KRC-977R/Ry	2-71	YES	YES	NO	NO	YES	NO	YES	0.22	C90-2822	1	1u50	1u50	47u10	360	22k	2k2	NO	YES	YES	NO
KRC-877R/Ry	2-72	NO	YES	NO	YES	YES	YES	YES	0.22	C90-5243	1	1u50	1u50	47u10	270	4k7	22k	YES	NO	NO	YES
KRC-777R/Ry	2-73	NO	NO	NO	NO	NO	NO	NO	0.12	C90-5243	0.47	1u50	1u50	NO	270	4k7	22k	YES	NO	YES	NO
KRC-877W/Wy	2-74	NO	YES	NO	NO	NO	NO	YES	0.22	C90-5243	1	1u50	1u50	47u10	270	4k7	22k	YES	NO	NO	YES

(X14-604x-xx)

MODEL NAME	UNIT No	R253,329	R254	Q1-4	IC1
KRC-PS1077R/Ry	2-70	YES	NO	2SD2114K	UPD784215
KRC-977R/Ry	2-71	NO	YES	2SD2114K	UPD784215
KRC-877R/Ry	2-72	NO	YES	2SC2412K	UPD784215
KRC-777R/Ry	2-73	NO	YES	2SC2412K	UPD784215
KRC-877W/Wy	2-74	NO	YES	2SC2412K	UPD784215

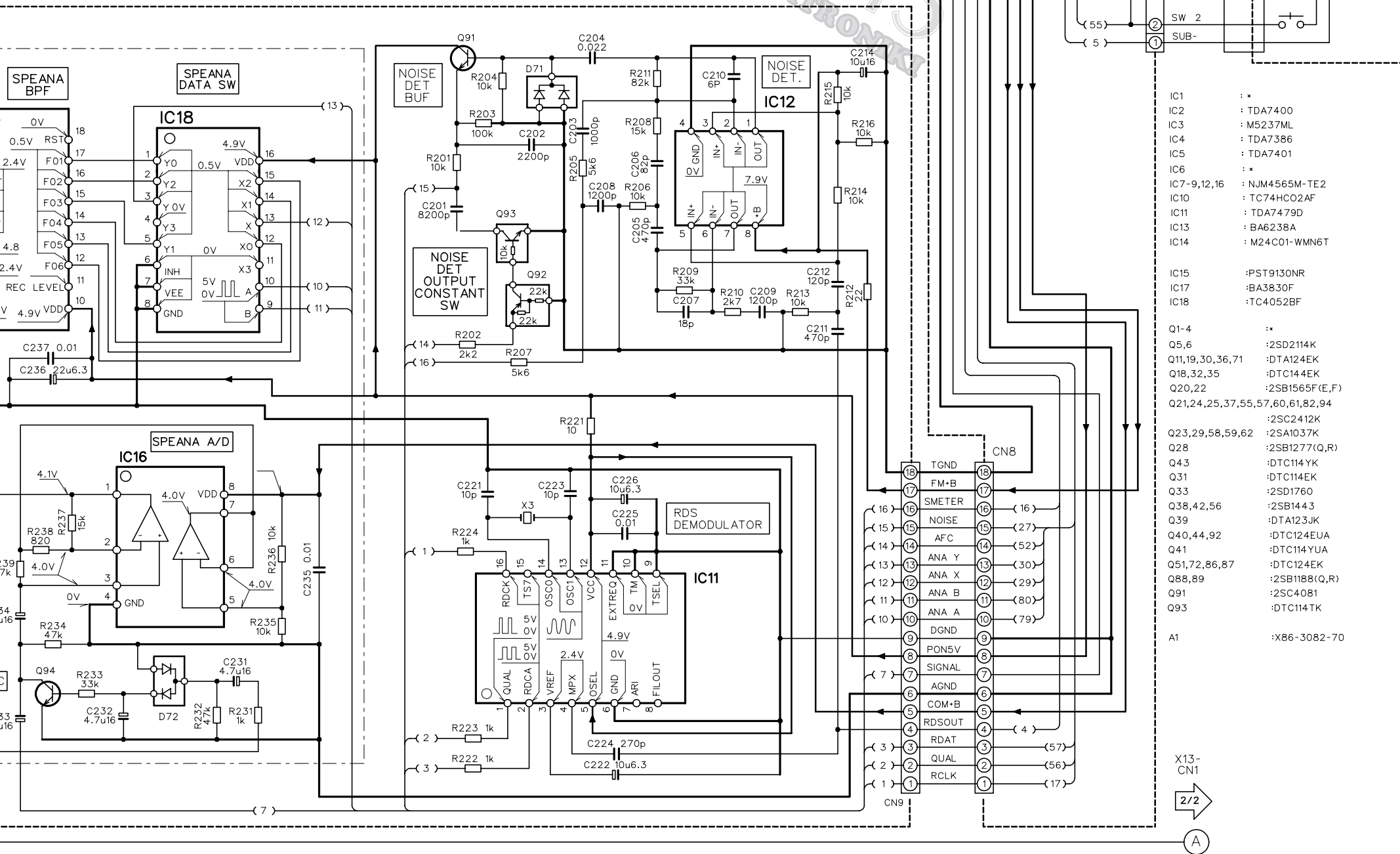

- IC1 : *
- IC2 : TDA7400
- IC3 : M5237ML
- IC4 : TDA7386
- IC5 : TDA7401
- IC6 : *
- IC7-9,12,16 : NJM4565M-TE2
- IC10 : TC74HC02AF
- IC11 : TDA7479D
- IC13 : BA6238A
- IC14 : M24C01-WMN6T

- IC15 : P8T9130NR
- IC17 : BA3830F
- IC18 : TC4052BF

- Q1-4 : *
- Q5,6 : 2SD2114K
- Q11,19,30,36,71 : DTA124EK
- Q18,32,35 : DTC144EK
- Q20,22 : 2SB1565F(E,F)
- Q21,24,25,37,55,57,60,61,82,94 : 2SC2412K
- Q23,29,58,59,62 : 2SA1037K
- Q28 : 2SB1277(Q,R)
- Q43 : DTC114YK
- Q31 : DTC114EK
- Q33 : 2SD1760
- Q38,42,56 : 2SB1443
- Q39 : DTA123JK
- Q40,44,92 : DTC124EUA
- Q41 : DTC114YUA
- Q51,72,86,87 : DTC124EK
- Q88,89 : 2SB1188(Q,R)
- Q91 : 2SC4081
- Q93 : DTC114TK

- A1 : X86-3082-70

2

IC1	IC6	J2	CP2 7	CP11	W1- 4	W5, 6	W7, 8	W33, 34	TAPE MECHANISM
34215GC075	TC7662BE0A	E63-0854(GOLD)	YES	NO	NO	NO	YES	NO	D40-1125-05
34215GC075	ICL7660SIBA	E63-0853(SILVER)	YES	NO	NO	YES	NO	NO	D40-1123-05
34215GC096	NO	E63-0853(SILVER)	NO	YES	NO	YES	NO	YES	D40-1123-05
34215GC096	NO	E63-0853(SILVER)	NO	NO	YES	NO	YES	YES	D40-1123-05
34215GC096	NO	E63-0853(SILVER)	NO	NO	NO	YES	NO	YES	D40-1123-05

KRC-PS1077R/KRC-PS1077RY/KRC-977R/KRC-977RY (1/2)
 KRC-877R/KRC-877RY/KRC-777R/KRC-777RY (1/2)
 KRC-877W/KRC-877WY (1/2)

X13-
CN1
2/2
A



Radio KRC-7 KRC-9

* (B38-1010-05)

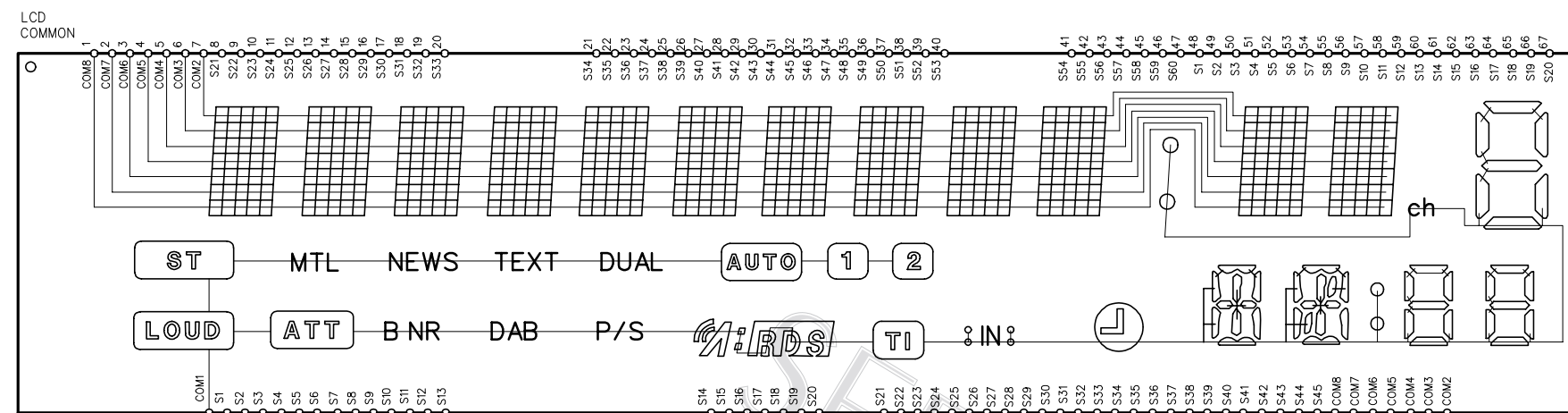
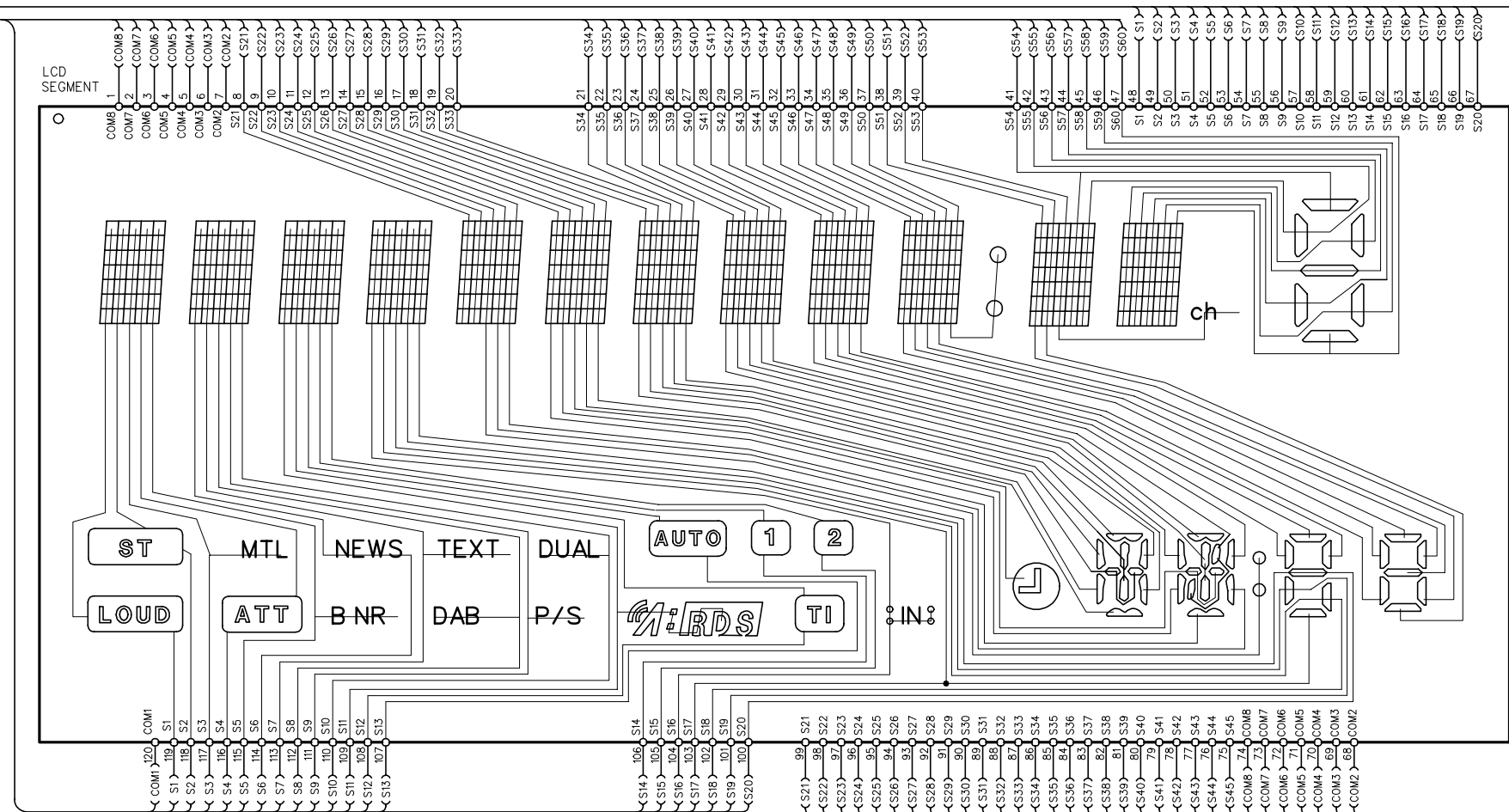

1

o samochodowe Kenwood -777R/Ry, KRC-877R/Ry/W/Wy, -977R/Ry, KRC-PS1077R/Ry

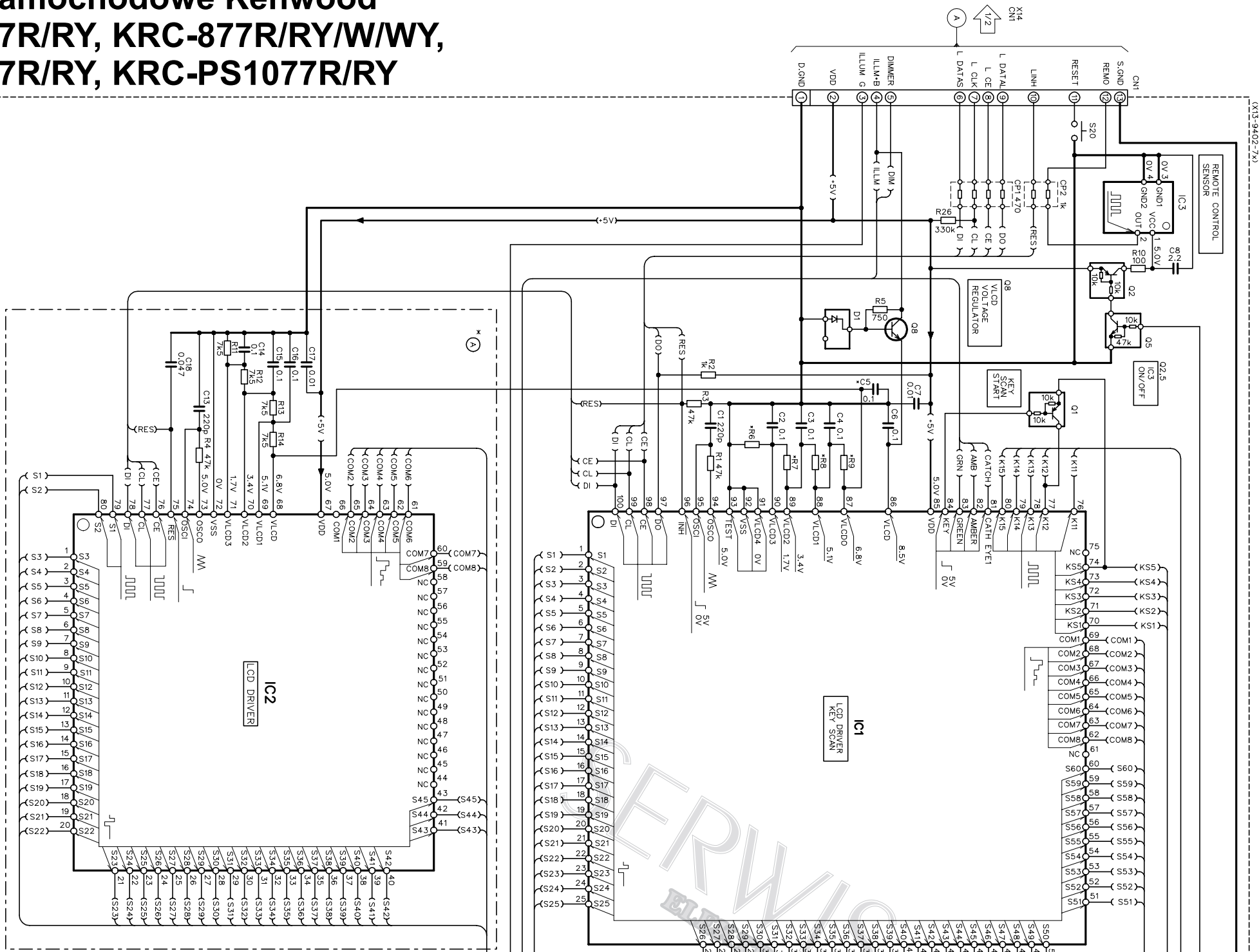

(K13-9402-7x)

2

* © (B38-1011-05)

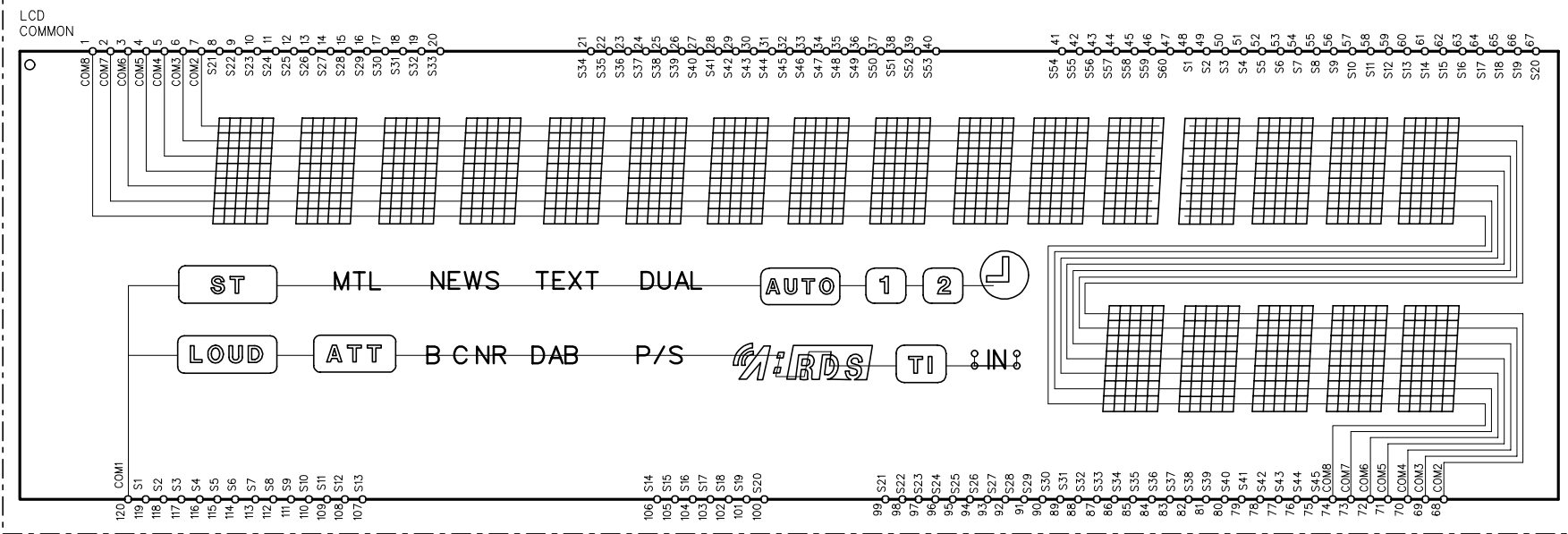
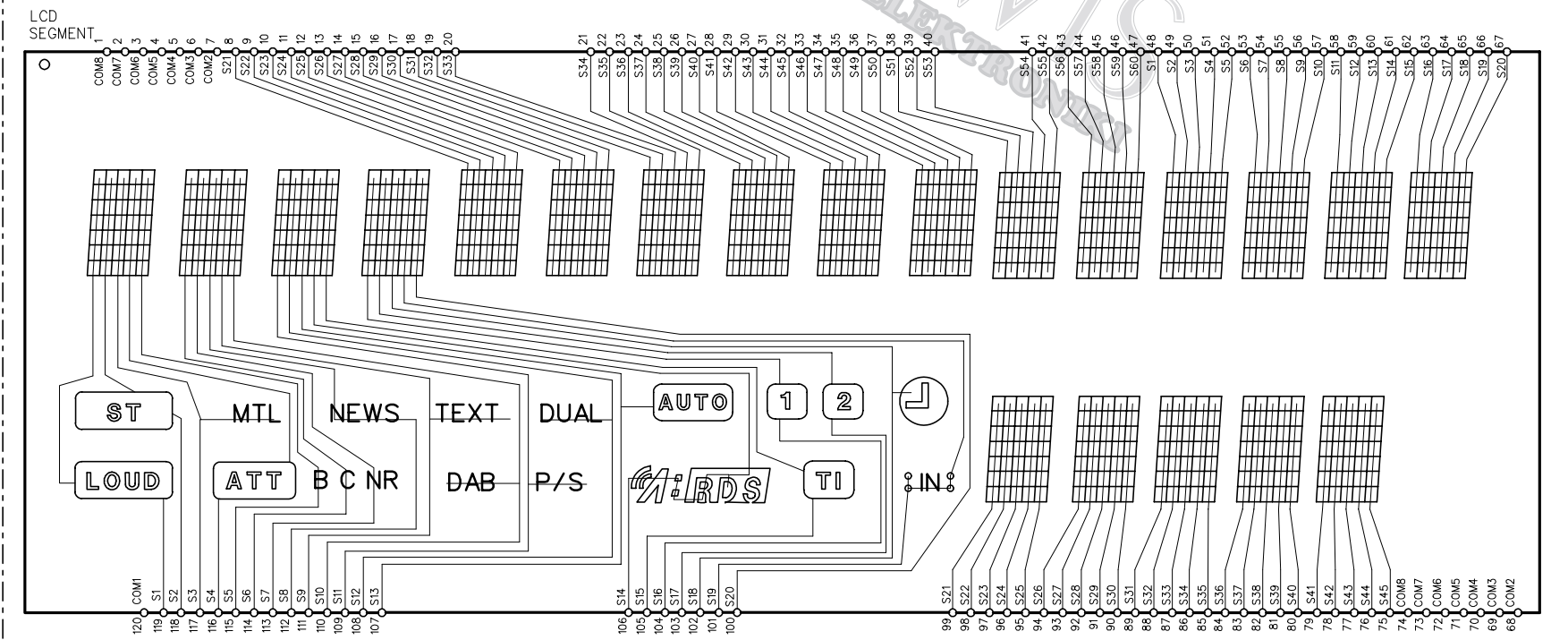

KRC-777RY	2-72	NO	YES	2x2	NO
KRC-877W					
KRC-877WY					

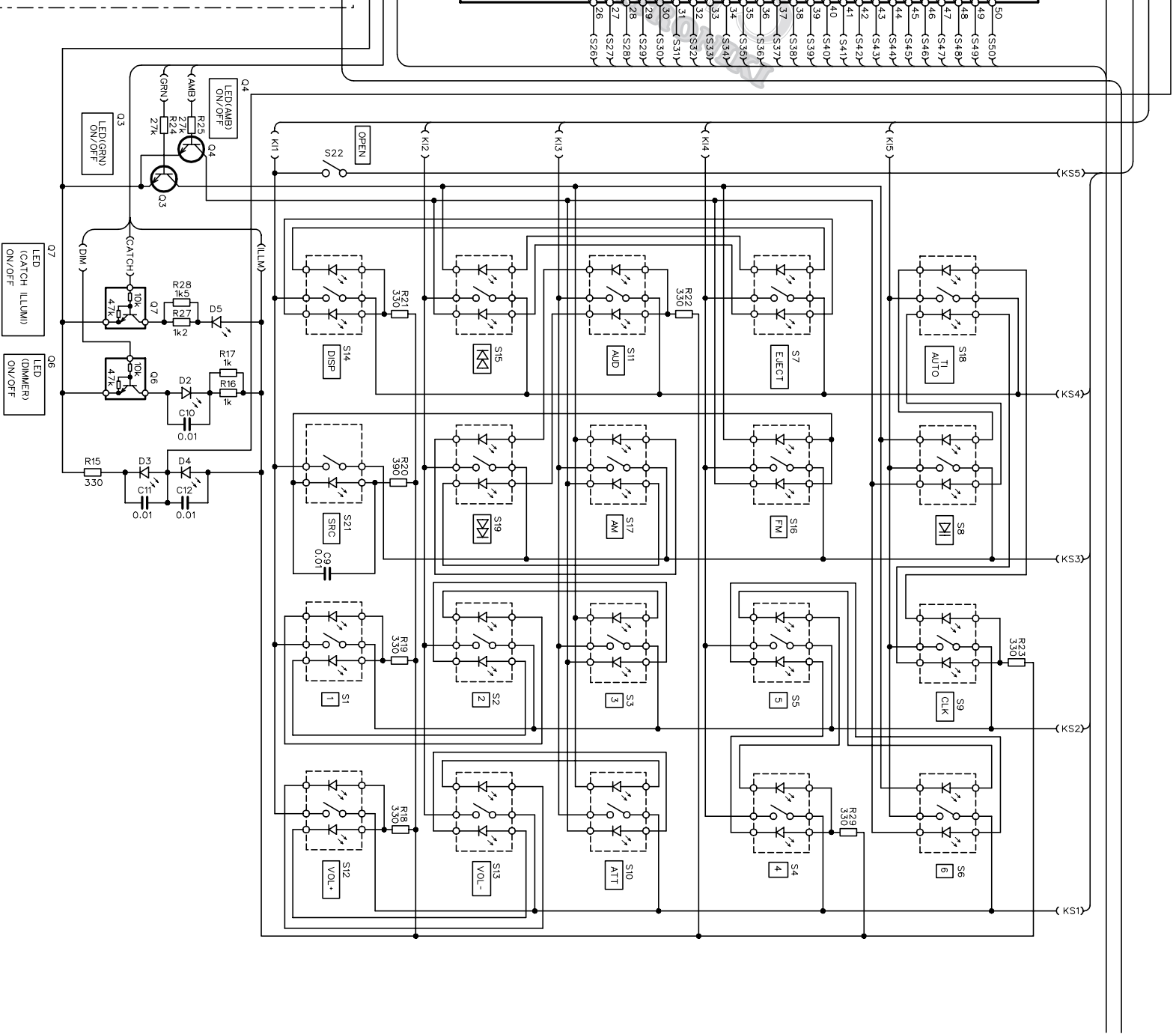

- IC1 . LC75817W Q1,2 : DT1A14EK or D1 : MA3091-M
- IC2 . LC75811W UN2111 D2-4 : B30-1542-05
- IC3 . RS-171 Q3,4 : 2SD2114K D5 : B30-1424-05

- Q5-7 : DTC14YK or UN2214
- Q8 : ZSC2412K or ZSD601A

— GND LINE
 -B LINE

MODEL NAME		UNIT No	(A)	(B)	Re-9	C5
KRC-1077R	KRC-1077R	2-71	YES	NO	7k5	YES
KRC-977R	KRC-977R	2-71	YES	NO	7k5	YES
KRC-877R	KRC-877R	2-72	NO	YES	2k2	NO
KRC-777R	KRC-777R	2-72	NO	YES	2k2	NO
KRC-877W	KRC-877W	2-72	NO	YES	2k2	NO
KRC-777W	KRC-777W	2-72	NO	YES	2k2	NO